

Data Sheet



Article number: 03510032

Description: Fluro Rod end GE 32SW

Measures

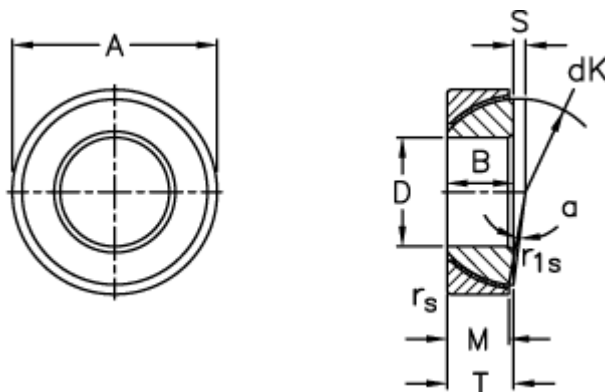

| | | | |
|---------------------|---------------|---------------------|------------------|
| A | = 58 0 -0,016 | Static load C0 (kN) | = 269 |
| B | = 17 | T | = 17 +0,25 -0,40 |
| D | = 32 0 -0,012 | Tilt angle | = 2 |
| dK | = 52 | Weight | = 241 |
| Dynamic load C (kN) | = 135 | | |
| M | = 16 | | |
| rs, r1s min | = 1 | | |
| S | = 2 | | |